

**SUIVEUR SOLAIRE À DEUX AXES SHS.345C
POUR ÉNERGIE SOLAIRE DE CONCENTRATION**

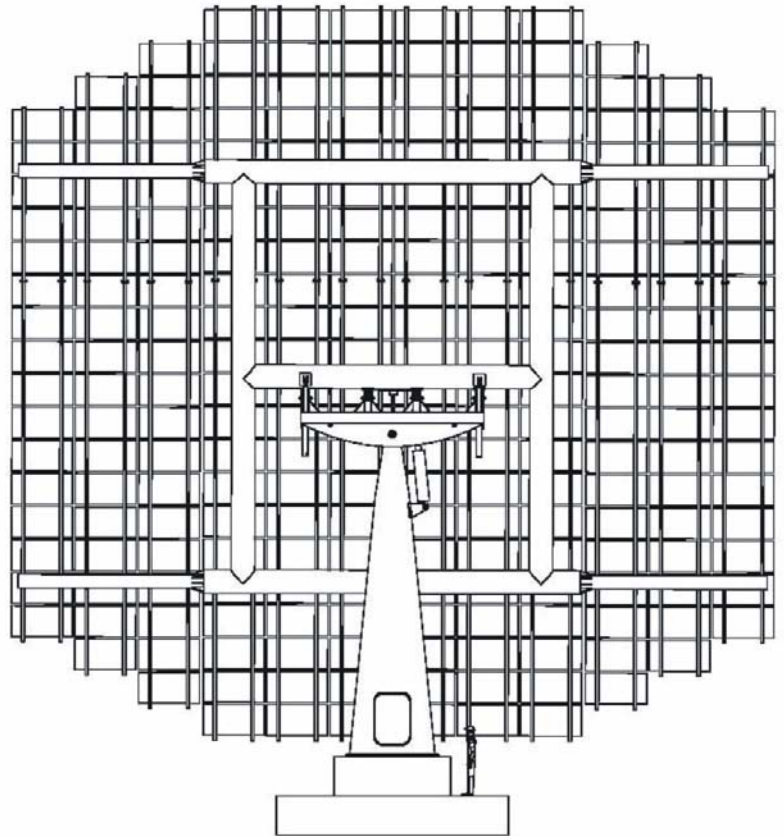

POSITION LEVANT

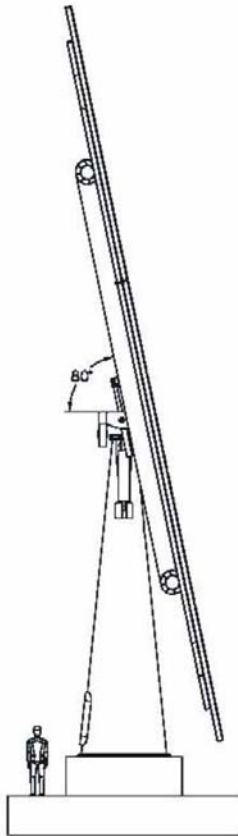
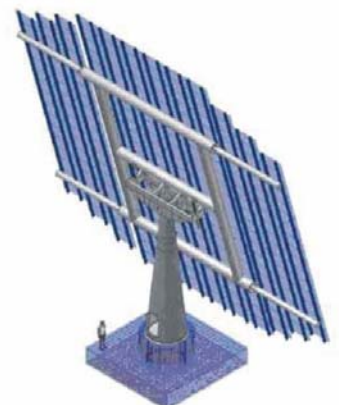

**SUIVEUR SOLAIRE À DEUX AXES SHS.345C
POUR ÉNERGIE SOLAIRE DE CONCENTRATION**

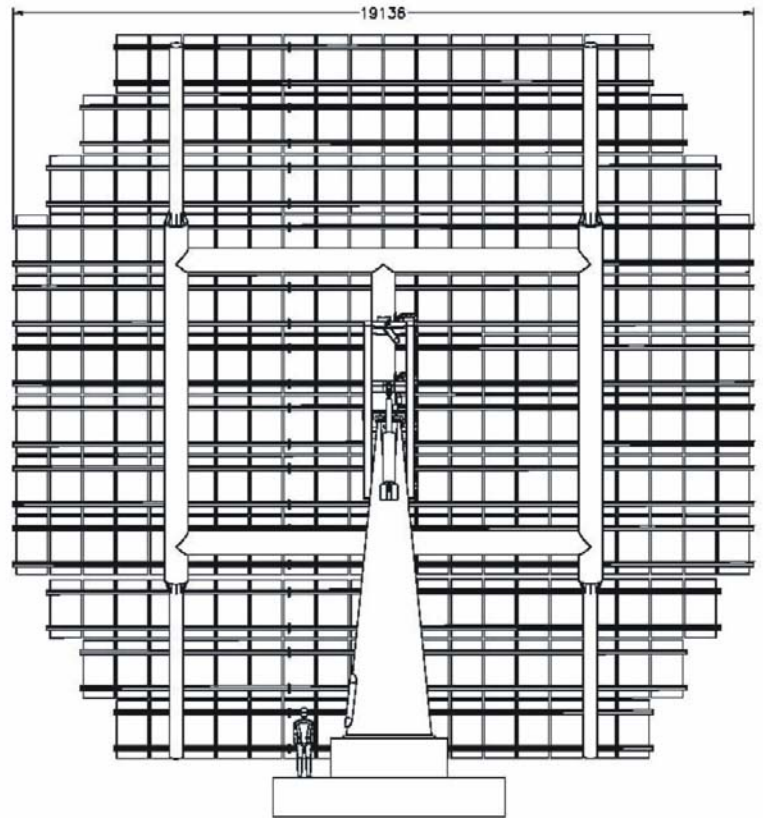
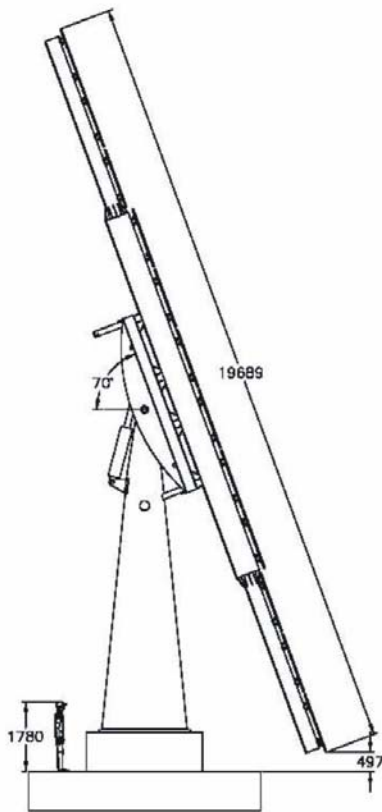

POSITION MIDI

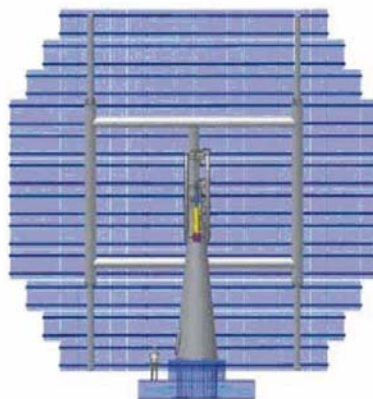
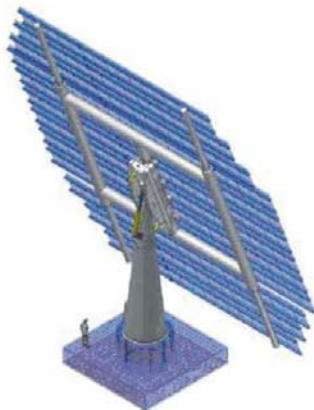

**SUIVEUR SOLAIRE À DEUX AXES SHS.345C
POUR ÉNERGIE SOLAIRE DE CONCENTRATION**

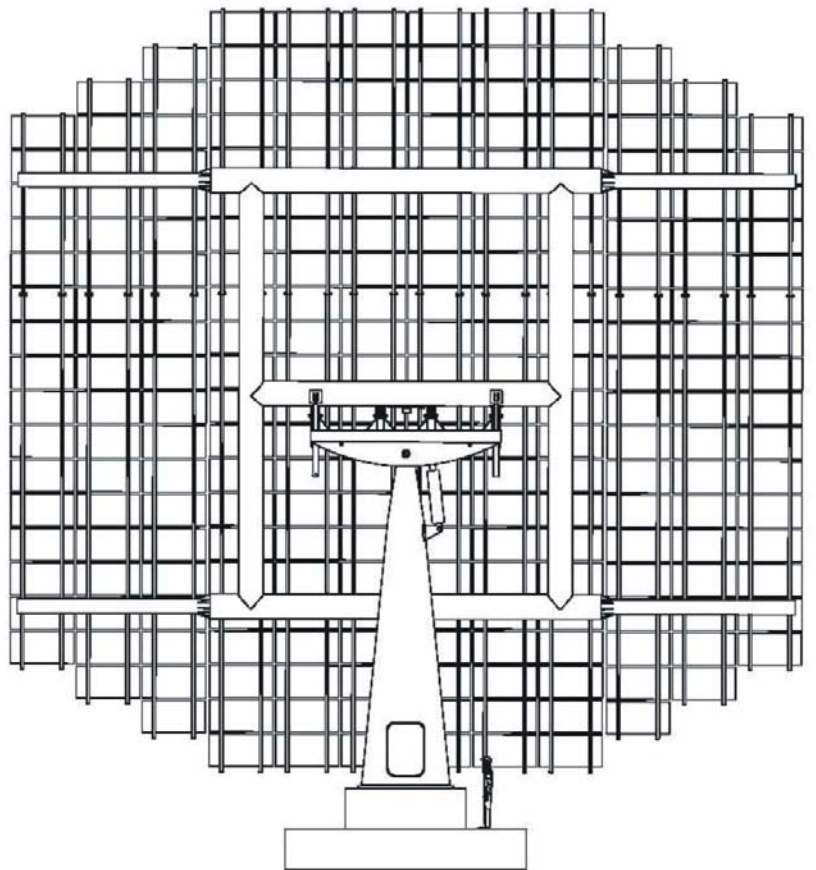
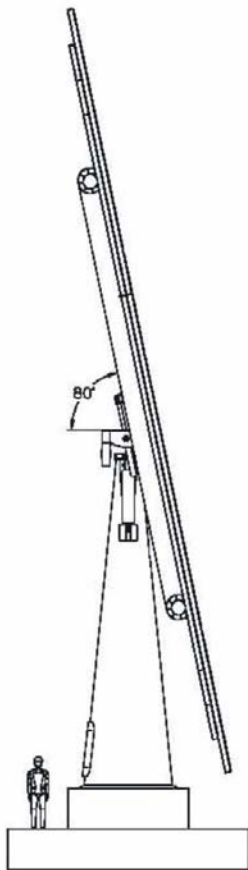

POSITION COUCHANT

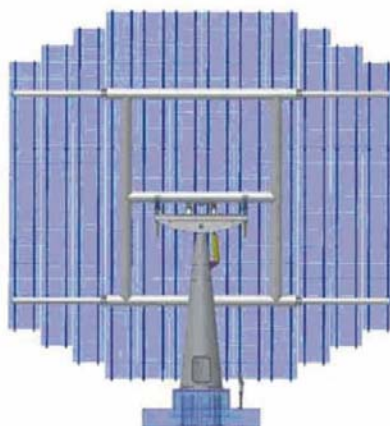
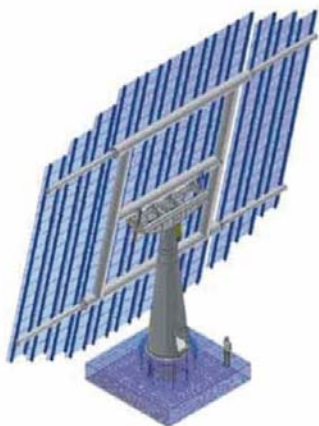

**SUIVEUR SOLAIRE À DEUX AXES SHS.345C
POUR ÉNERGIE SOLAIRE DE CONCENTRATION**

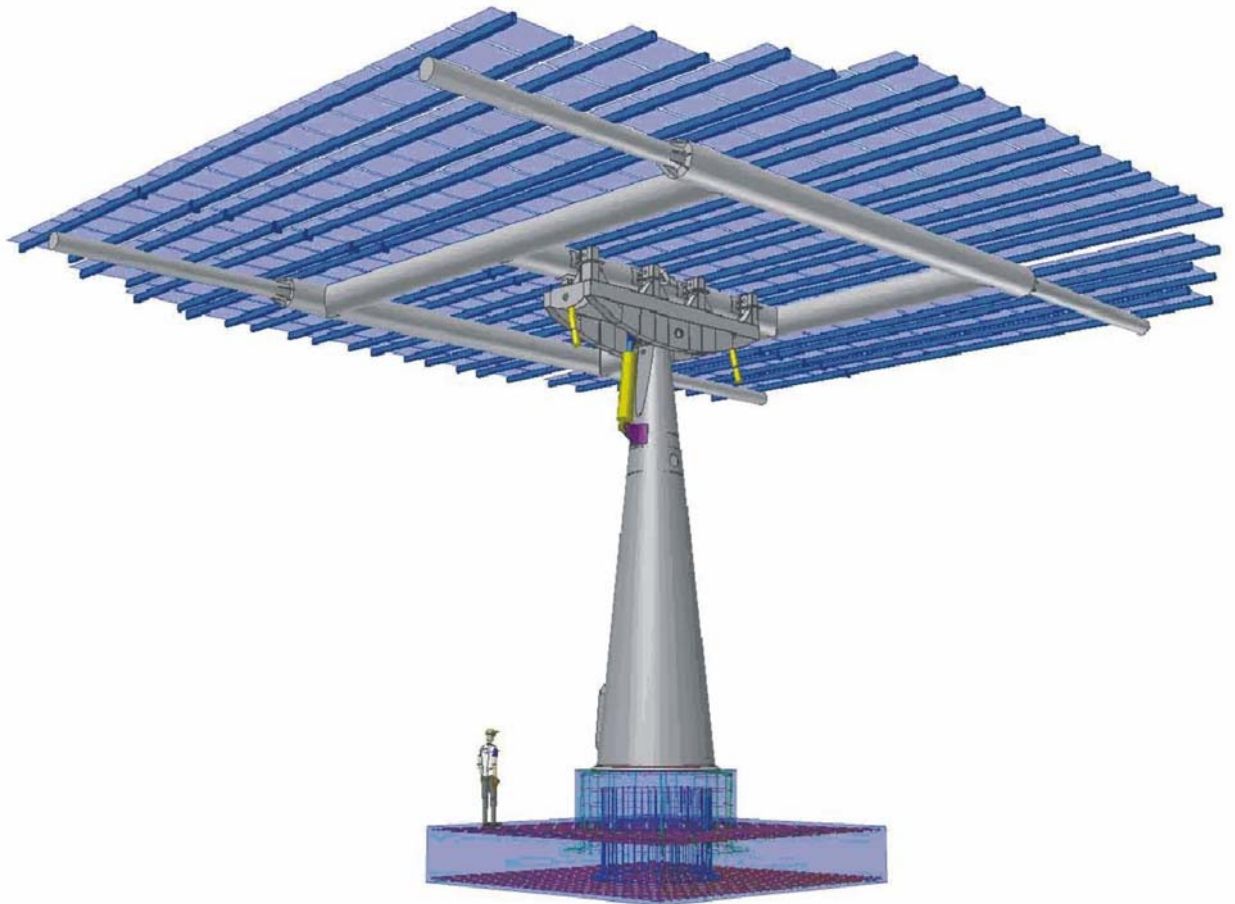

POSITION DE SÉCURITÉ OU NOCTURNE

